

Japanese atomizing technology: solution for flue-gas desulphurization and denitration





IKEUCHI Spray Nozzles for air pollution control system

“The Fog Engineers” H. IKEUCHI & Co., specializing in developing and manufacturing spray nozzles for over 60 years, have always contributed towards a cleaner and more environment friendly surrounding.

After establishing our very own Environment Division we soon realized that the industries have many issues that needed urgent attention. In the 1970s we introduced our first nozzles for the pollution control industry and to date our spray nozzles are used in hundreds of Utility plants.

As “The Fog Engineers” we understand the significance of droplet size and full evaporation in gas cooling towers for example, to ensure maximum cooling effect without extra drainage. Therefore, we have a wide range of nozzles with different droplet sizes and spray capacities to suit every request. Customers realize lower running costs and minimal maintenance downtime with our clog-resistant nozzles and wide range of material options.

We offer solutions for **Air Quality Control Systems (AQCS)**, such as **FGD process**, and **SCR / SNCR**, by reducing particulate matter in an exhaust gas from coal fired power plants, refineries, chemical plants, steel mills, paper mills, etc.

We can offer solutions that are suitable for each AQCS process with tailored nozzle design and materials. Our nozzles are also used for flue gas cooling as a Dioxin countermeasure, desulphurization and denitrification devices to reduce NOx and SOx in Flue gas treatment plants, Odour reduction, Heat reduction, Dust suppression and Gas cooling.

We offer our nozzles and engineering expertise to the Pollution Control Industry and pledge to assist the European Industry to reach their emission targets and contribute to a greener, healthier environment.

In this leaflet, we introduce some of our leading nozzles from our wide lineup for pollution control nozzles.

IKEUCHI Group - Japanese highly controled quality product

A high quality is our standard. Therefore, as a manufacturer we use advanced inspection equipment to guarantee the performance of the spray nozzles in terms of spray capacities and spray angles.

Innovation is key. Our R&D department are focusing in producing optimal nozzle to solve our customers' issues.

Throughout the years, IKEUCHI Group has focused on improving our solutions to adjust to customers' needs and offer the best solutions suitable for them.

Control of the spray performance



Measurement of droplet size by Laser Doppler analyzer



TAA series Large Capacity, Hollow Cone Spray Nozzles for FGD

- **High wear and acid resistance**

Made of wear-/acid- resistant clog-resistant SiC (silicon carbide). Also available in SiSiC (siliconized silicon carbide).

- **Designed for low-pressure operation**

Due to its unique internal design, the spray angle and spray distribution are stable even at 0.03MPa (ca. 0.3bar).

- **Large free passage diameter**

No internal parts to minimize clogging issues.



Variation of spray angle and distribution at low pressure

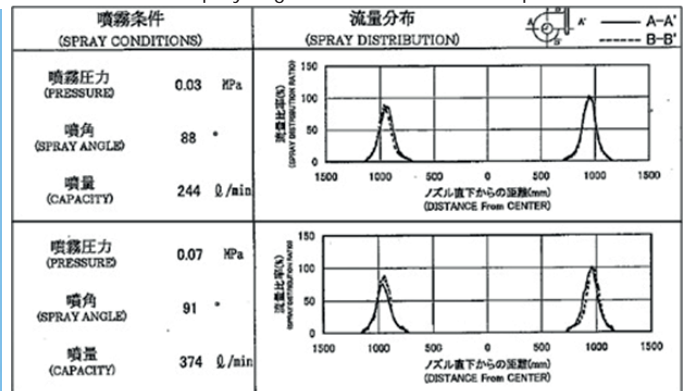

Bi-directional slurry spray nozzle for FGD

TWAA series Bi-directional, Hollow Cone Spray Nozzles for FGD

- **Wear-resistant, Lightweight**

- Made of SiC / SiSiC (silicon carbide / silicon infiltrated silicon carbide) with excellent wear-resistance and chemical durability.
- Weighs less than half the weight of stainless steel.

- **Bi-directional spray**

- The TWAA series is bi-directional, so one nozzle unit can take the place of two.
- The result: simpler equipment layout, less maintenance, and reduced costs.

- **Smaller droplets**

- With 2 orifices, the flow normally sent through 1 orifice is halved, yielding smaller droplets.
- Best for applications with contact / reactions.

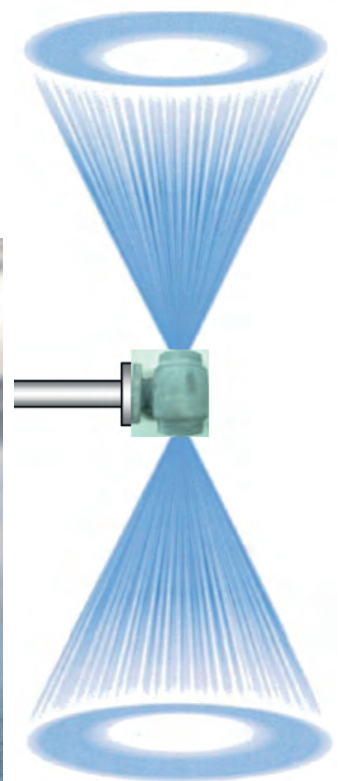

Clog-resistant SNCR Nozzles

DOVVA-G series - Flat Spray Pneumatic Spray Nozzles for SNCR

○ Clog-resistant design

Pneumatic spray nozzle suitable for spraying aqueous ammonia and urea. Due to its large passage diameter, it also minimizes clogging.

○ Semi-fine atomization

Produces semi-fine atomization with a mean droplet diameter of 80µm or more*.

○ Heat-resistant materials (option)

In addition to the standard material Stainless Steel 316L, nozzle tip is also available in heat-resistant steel such as Stainless Steel 310S.

*measured by Laser Doppler Method

○ Example of an installation

To cover a wide area with an even distribution, alternate a wide angle spray nozzle with a narrow angle spray nozzle (spray angle from 30° to 110°).

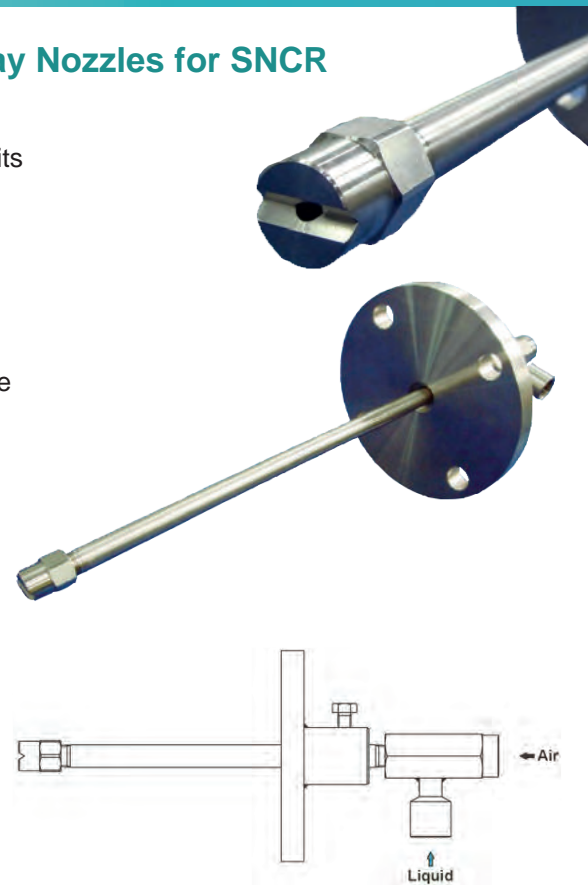
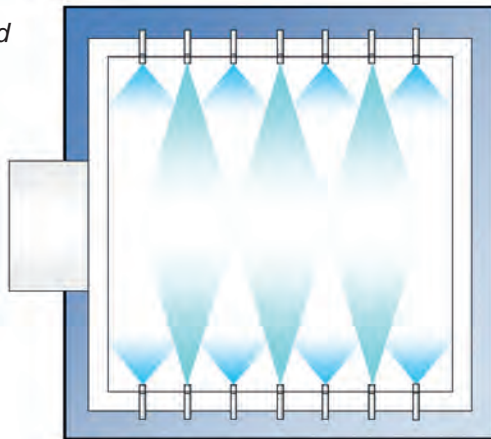

Fine Atomization SCR Nozzles

SETOJet series Clog-resistant Fine Fog Nozzles for SCR

○ Designed for the application environment

- Liquid pipe is set inside the air pipe so that liquid is not affected by heat.
- Designed to mix air and liquid outside the nozzle, clogging due to precipitated liquid is minimized.
- Protector has an air purging hole to protect the nozzle and liquid from heat.
- Odor-tight structure.

○ Optimal spray lance for your equipment or the environment

- Integrated spray lance requires no troublesome piping around the nozzle.
- Easy to remove the spray lance from the equipment at site.
- Spray direction can be chosen as desired, straight type or angled type, depending on the equipment and installation position.

○ Selectable from various models

- Available in 18 spray capacity types from 2 l/hr to 120 l/hr.

External mixing spray nozzles

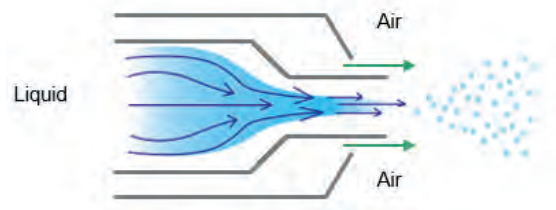

NEW SETOJet series nozzle tip to solve clogging issues

NEW

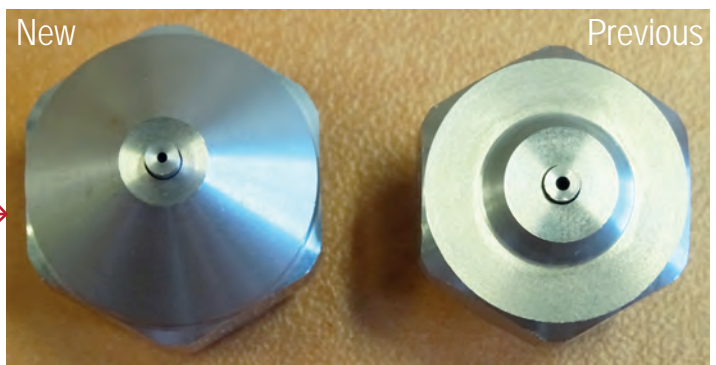

Optional equipment for a long-life application

To ensure a long-life application of our product, we offer optional equipment to protect them from:

- Heat damages: figure 1 of an injection lance used for 1 month in a boiler tube with ca. 1000°
- Clogging issues: figure 2 of a clogged nozzle tip with crystallized urea
- Exterior deterioration: figure 3 of a damaged nozzle tip due to fly ash particles scrubbing against it and changing its shape

Figure 1 - Heat damage on a stainless steel injection lance



Figure 2 - Crystallized urea

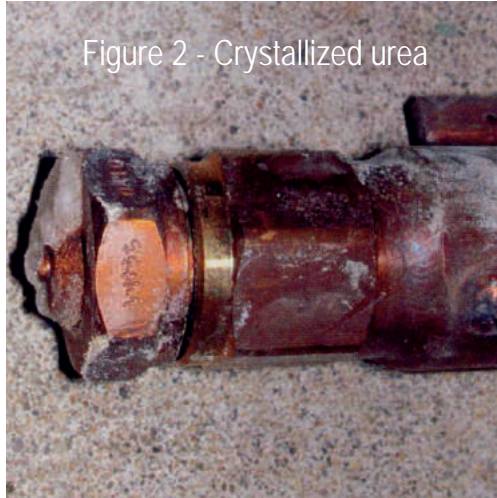
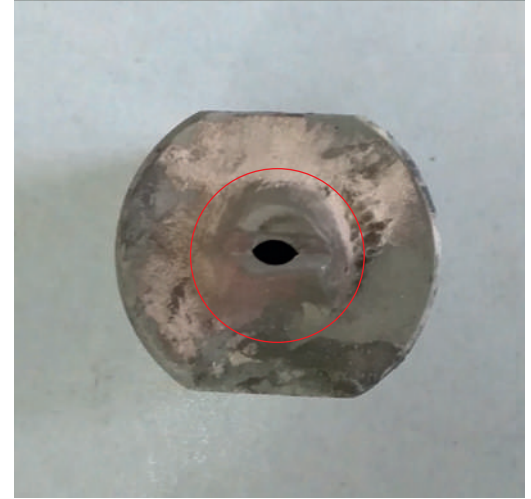
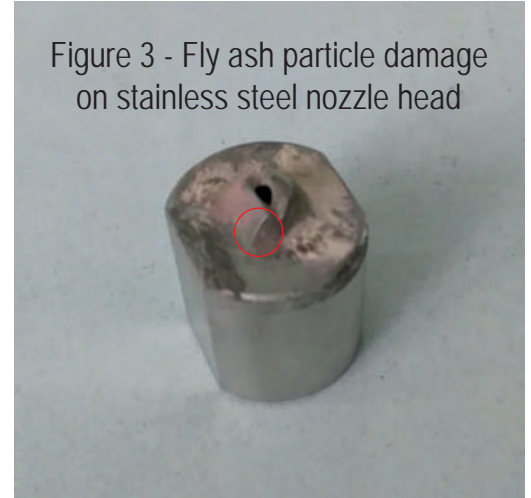
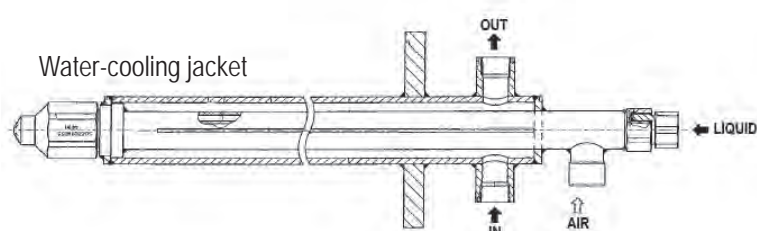
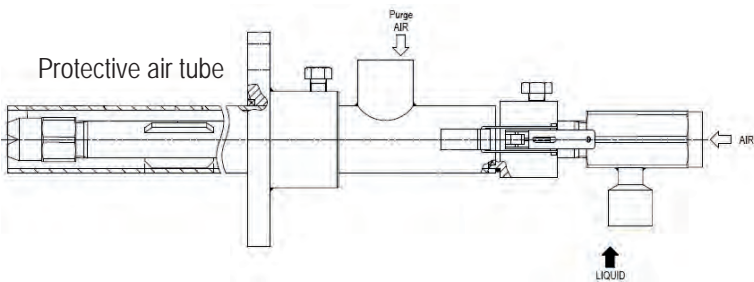

Figure 3 - Fly ash particle damage on stainless steel nozzle head



○ You can customized our nozzles with multiple options depending on your application:

- Protective air tube
- Water-cooling jacket
- Retracting mount equipment



Retracting mount equipment

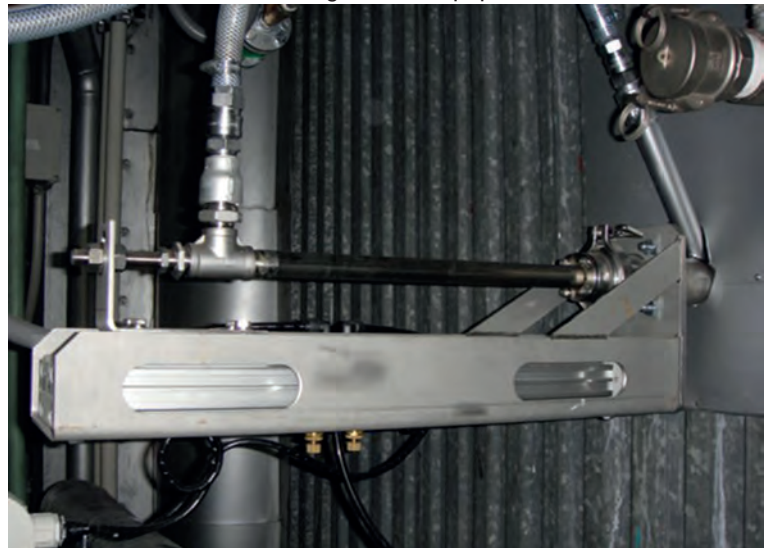

GSIMII series - Fine Fog Pneumatic Spray Nozzles for Gas Cooling

Patented

○ Downsize gas cooling tower

The number of required nozzles can be minimized with GSIMII, which combine large spray capacity and fine fog of $50\mu\text{m}^*$. This allows, for a smaller gas cooling tower design than normal, reducing construction and maintenance costs.

○ Large spray capacity with excellent atomization

GSIMII's average droplet size is $50\mu\text{m}$ (largest droplet size $150\mu\text{m}$) with a spray capacity of 500l/hr at an air-water ratio of 130.

○ Nozzle tip available in optional materials

The nozzle tip is also available in corrosion resistant material such as Hastelloy®.

**mean droplet diameter by Laser Doppler Method*

Example of control system

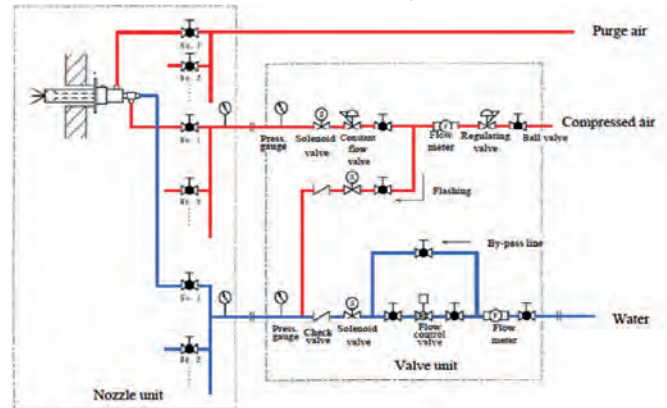

ASPB series - Air-assisted Spillback Nozzles

NEW

○ Pneumatic type of spillback nozzles

- Energy-saving "return type" with reduced air consumption compared to standard pneumatic spray nozzles.
- Adding compressed air supply line to the existing facility can solve various problem.
- High-velocity fog is not disturbed by flow of exhaust gas and reaches the center of the gas cooling tower.

○ Energy saving design for less air consumption

- Higher cooling capacity than conventional spillback nozzles.
- Reduced air consumption.
- Reduced unvaporized-water drainage and problems caused by dust adhesion to interior walls or around outlet of gas cooling tower.

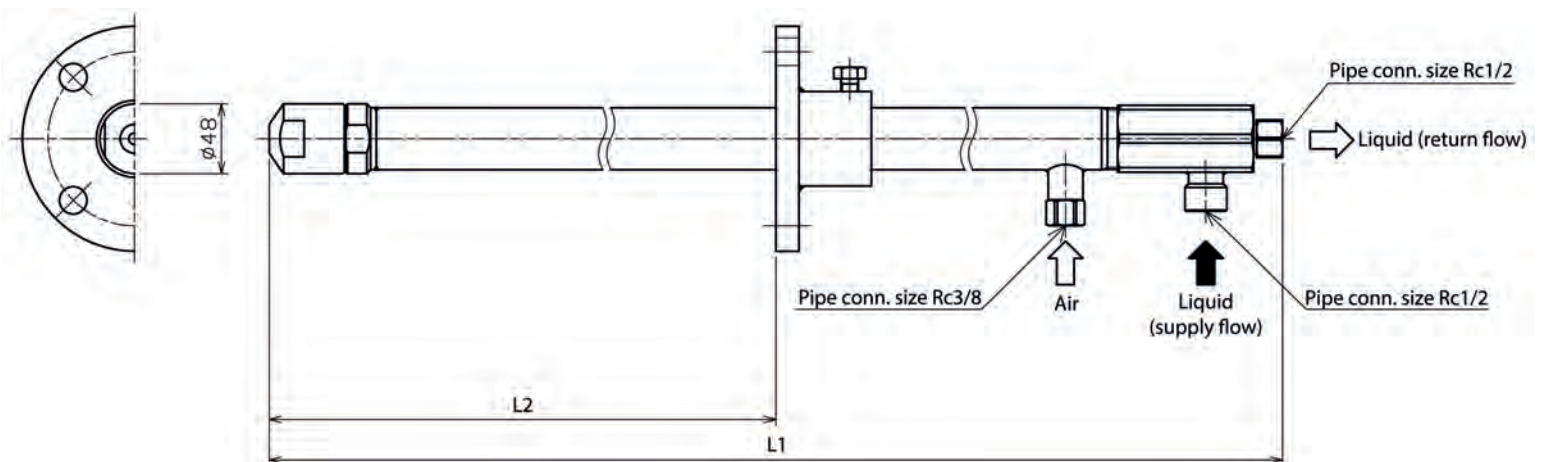

SPB series - Spillback Nozzles for Gas Cooling

Patented

Minimal variation in droplet sizes

Spray capacity can be controlled by adjusting the return pressure while keeping the supply pressure constant. Turn-down ratio of spray capacity is 1:10. The variation in sprayed droplet size is minimal despite the modulation of spray flow.

Wide range of spray capacities

SPB series is available as a single-head or multiple-head nozzle. The single-head SPB nozzle is available in 60° and 85° spray angles, and with 15 different spray capacities according to nozzle arrangement and gas conditions in the cooling tower. Multiple-head SPB nozzles are suitable when a larger spray capacity is required, with a spray angle up to 140° or even wider, but with minimal increase in spray droplet size.

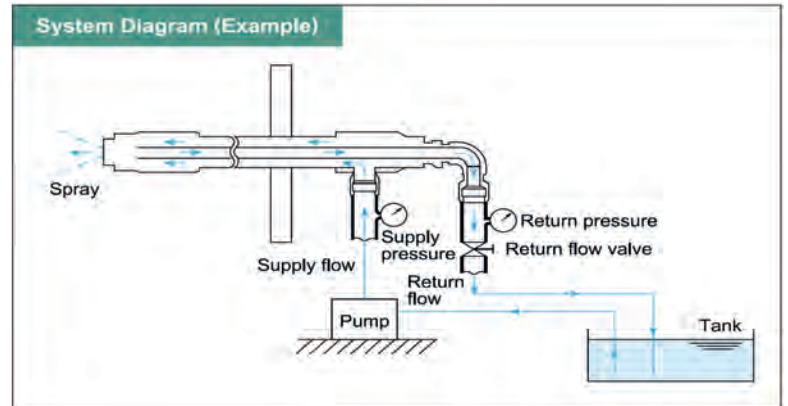

Single-head SPB nozzle

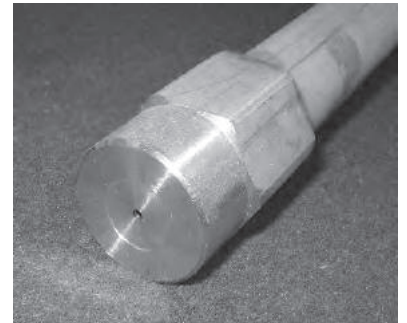
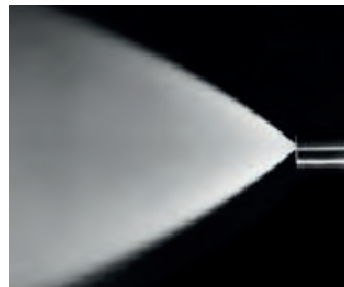
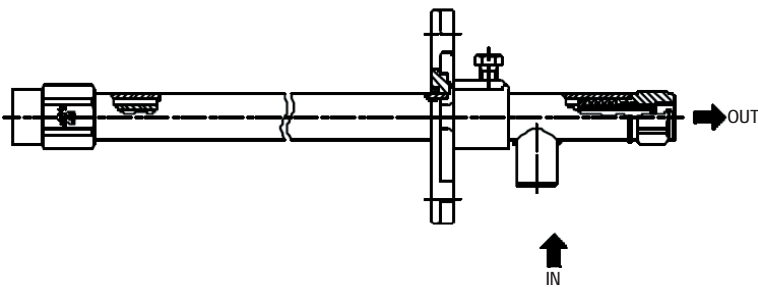

Multiple-head SPB nozzle

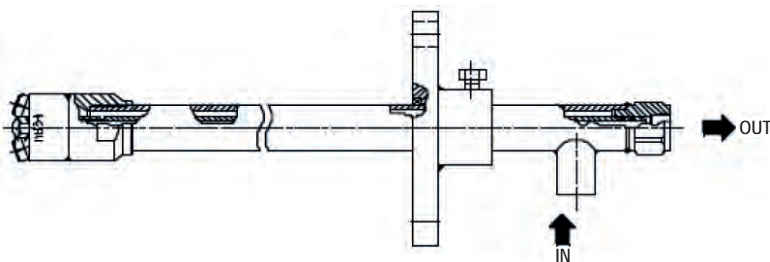

Patented

JOKIJet® series

Steam-driven nozzles, JOKIJet® series use steam instead of compressed air to atomize liquid.



Based on your gas cooling conditions, we can offer the most suitable nozzle arrangement and spraying conditions.

Please request a "Specifications Check Sheet" from us so we can confirm your requirements.

Providing nozzle selection and spray conditions

Based on the "Specifications Check Sheet" you complete, we select suitable nozzles and send our suggestion report, in which we include suitable spray conditions and spray droplet sizes required for full evaporation confirmed by our original program.

Nozzle lances, flanged connections, and other optional mounting systems are custom-built to meet your specifications.

Test report

In order to support spray conditions, we can provide testing reports of actual measurement of the various parameters such as:

- Droplet size and distribution by laser Doppler particle analyzer
- Spray dimension and coverage measurement

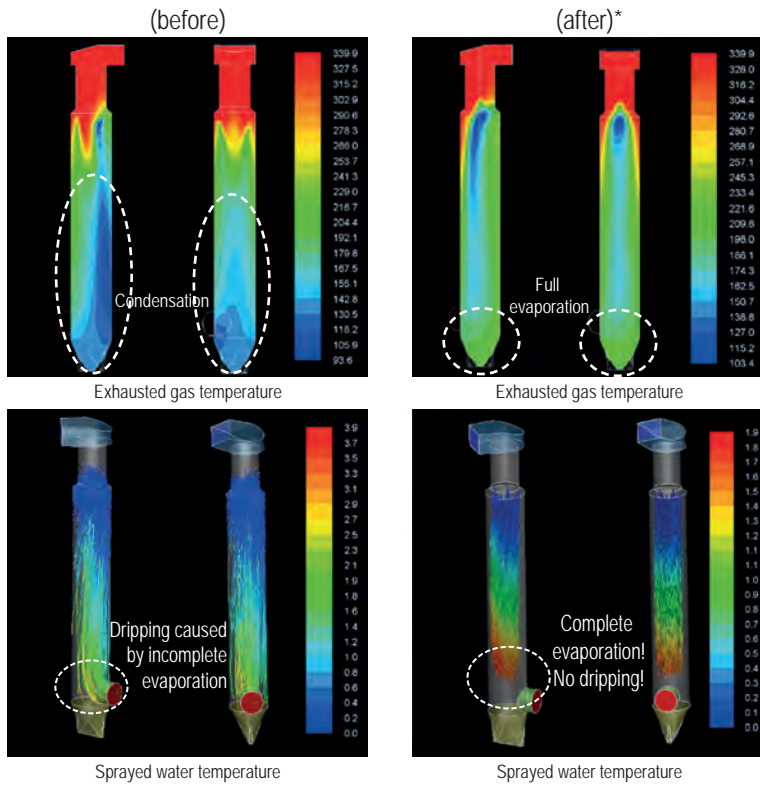

*Depending on suggested solution by IKEUCHI

Suggestion reports on your gas cooling information

Suggestion on Gas cooling Nozzle (For Pneumatic Nozzle)



Customer:		Date:	18 April 2018
Person in charge:		Name:	
End User:			
Application:	Gas cooling		
Type of Furnace:			

<INPUT>		<OUTPUT>	
Gas Volume	10000 Nm ³ /hr	Required spray volume	1133 L/hr
Temp. of Inlet Gas	300 °C	Cooling time	18.9 L/min
Temp. of Outlet Gas	80 °C	Required droplet size (Immersion sampling method)	9.6 sec
Temp. of spray water	20 °C	Max dia. (d max)	231 μm
Specific gravity of Air	1.29 kg/Nm ³	Surmised average dia.(SMC)	61 μm
Pressure inside of tower	-4 kPaG	Required droplet size (Laser doppler method)	
Inner Dia. of cooling tower	3 m	Max dia. (d max)	184 μm
Height of cooling tower (Distance for evaporation)	7 m	Surmised average dia.(SMC)	56 μm
		Average gas velocity	0.7 m/sec

Nozzle series	GSIM	Surmised spray conditions	Surmised droplet size
Nozzle name	GSIM20110II	Supplied air pre. 0.35 MPa	Immersion sampling method(dms) μm
		Air consumption 1000 NL/min	Immersion sampling method(SMC) μm
Number of Nozzle	4 pc(s)	Supplied water pres 0.3 MPa	Laser Doppler method (X99) μm
Capacity of each nozzle	283.1 L/hr	Spray capacity 283 L/hr	Laser Doppler method (SMD) μm
	4.7 L/min	Air-water ratio 212	

CFD analysis

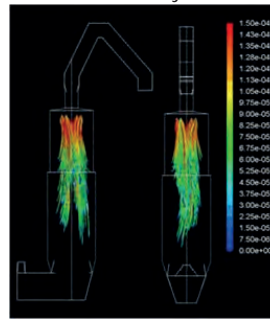

Selection factor for gas cooling nozzle -Proposal Ex.1-

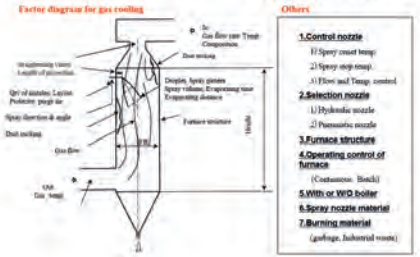

Actual spray dimension and coverage data

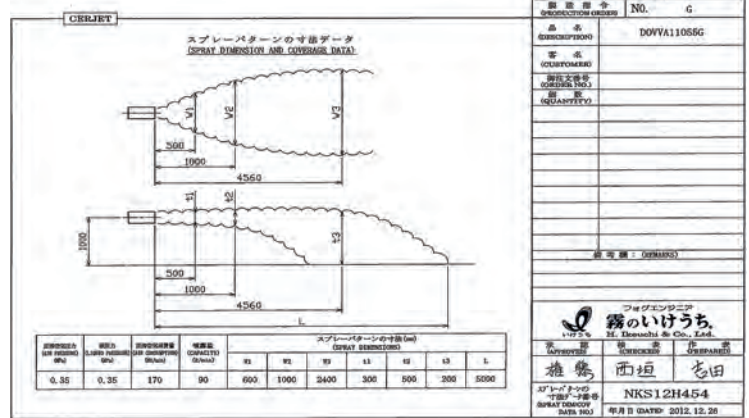

"The Fog Engineers" IKEUCHI EUROPE B.V.

IKEUCHI EUROPE B.V.

Merwedeweg 6,
3621 LR Breukelen
The Netherlands

Tel: 0031-20-820-2175

info@ikeuchieurope.com

https://www.ikeuchi.eu



"Taking the path less traveled"



「人の足跡を踏むな」